

## Daily/Weekly Maintenance

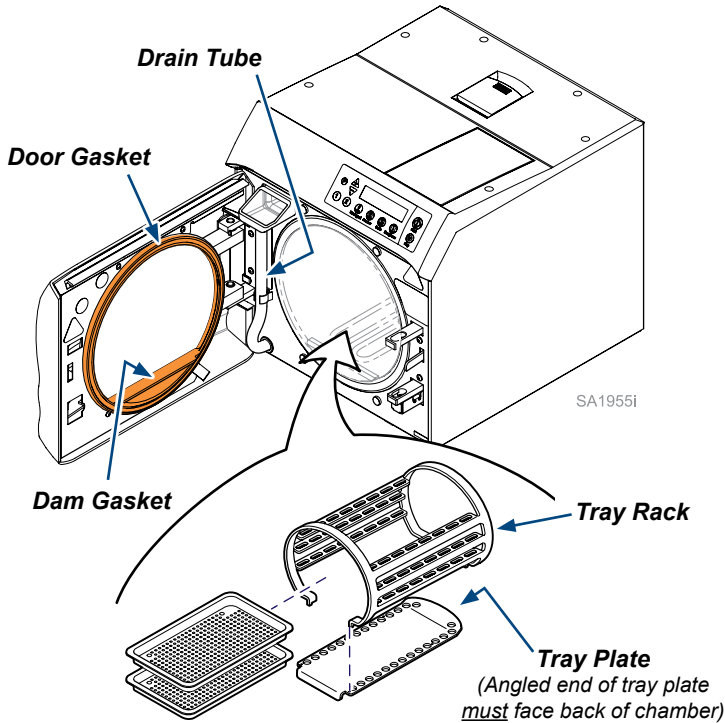

### Caution

To prevent burns, allow unit to cool before cleaning gaskets and internal surfaces.

## Daily:

### • Clean External Surfaces and Gaskets

- Wash exterior of sterilizer according to your facility's procedure for clinical contact surfaces. Use only quaternary disinfectants to disinfect unit. See User Guide for more information.
- Examine door gaskets for damage. Clean gaskets and mating surfaces with a damp cloth.

## Weekly:



### Equipment Alert

Failure to change water may result in sterilizer malfunction. Do not use bleaching agents or any abrasive materials / substances in chamber (i.e. bleach, steel wool, wire brush, scouring powder, etc.). Failure to comply may result in damage to the chamber and/or other components.



### Caution

To prevent burns, allow unit to cool before draining reservoir.

### • Clean Internal Surfaces

- Drain water from the reservoir using drain tube on front of unit.
- Remove trays, tray rack, and tray plate.
- Wash removed items and inside chamber with mild soap or Speed-Clean and water\*\*.
- Refill reservoir with clean water\*\*.

## Monthly Maintenance

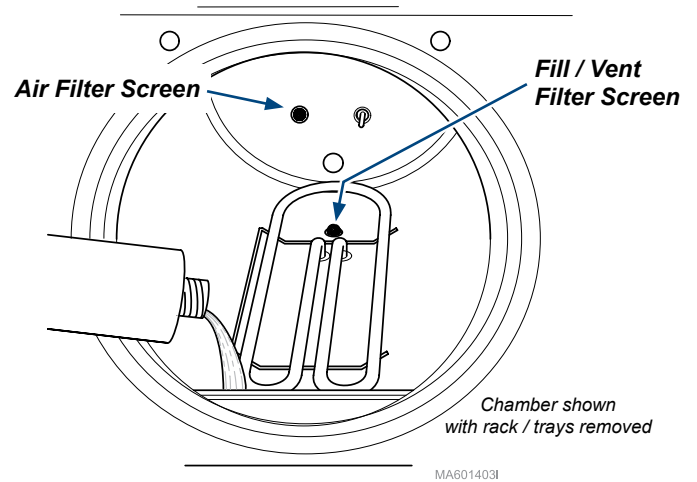

### WARNING





Do not process instruments while flushing system.



### Equipment Alert

Use only Speed-Clean to flush system. Failure to flush system with Speed-Clean may result in the premature failure of sterilizer components.

### • Flush System

- With a cooled chamber, drain reservoir and fill with clean water\*\*. Add one ounce of Speed-Clean sterilizer cleaner directly to the bottom of chamber.
- Run one **Pouches** cycle. 
- Press **Stop** button  when Dry Cycle begins.
- Drain reservoir and refill with clean water\*\*.
- Rinse by running one **Unwrapped** cycle.  Press the "Stop" button  when the drying cycle begins.
- Drain and refill reservoir with clean water\*\*, then allow sterilizer to cool.

### • Clean Filter Screens (fill / vent , and air)



### Equipment Alert

Do not operate sterilizer without filters in place.

- Allow sterilizer to cool, then remove trays / rack / tray plate.
- Refer to the illustration for location of filter screens.
- Pull / twist filter to remove. (Use pliers if necessary).
- Clean filters with Speed-Clean and water\*\*. (Replace filters if debris cannot be removed by cleaning).
- Rinse filters with water\*\*.
- Install filters. (Press inward while twisting slightly).
- Install tray plate, rack, and trays.

### • Check Pressure Relief Valve\*

### • Remove / Clean / Inspect Gaskets\*

\*\*Water when referenced is defined as distilled water or water that meets the water purity specifications found in the User Guide.

## To start a cycle...





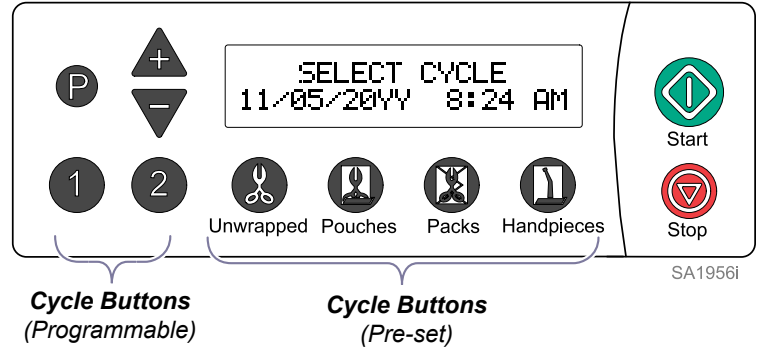

### WARNING

If the Stop button is pressed before the Dry Cycle begins, the load is not sterile.





- Press the desired **Cycle Button**.  
(Refer to 'Cycle Parameters' for times / temperatures).
- Press the **Start** button.







Cycle Type	Cycle Parameters			Drying Time <sup>2</sup>	Items to be Sterilized (Always consult the item manufacturer's recommendations for sterilization.)
	Temp (min)	Time	Press. <sup>1</sup> (Ref.)		
 Unwrapped	270°F (132°C)	3 min.	27.1 psi (186 kPa)	30 min.	<ul style="list-style-type: none"> <li>Instruments loose on a tray.</li> <li>Open glass or metal canisters.</li> <li>Tubing not used in surgical procedures. (Max. length - 40" and Min. inside diameter - .187")</li> <li>Loose items manufacturers recommend for exposure at 270°F (132°C) for 3 minutes.</li> </ul> <p>Note: The sterility of unwrapped items is compromised on exposure to a non-sterile environment.</p>
 Pouches	270°F (132°C)	4 min.	27.1 psi (186 kPa)	30 min.	<ul style="list-style-type: none"> <li>Pouched or loosely wrapped instruments.</li> <li>Multiple layers of instruments separated by fabric.</li> <li>Wrapped trays of loose instruments.</li> <li>Wrapped cassettes.</li> <li>Wrapped items manufactures recommend for exposure at 270°F (132°C) for 4 minutes.</li> </ul>
 Packs	250°F (121°C)	30 min.	15 psi (104 kPa)	30 min.	<ul style="list-style-type: none"> <li>Textiles and surgical packs wrapped for sterilization.</li> <li>Items, except liquids, manufacturers recommend for exposure at 250°F (121°C) for 30 minutes.</li> </ul>
 Handpieces	270°F (132°C)	4 min.	27.1 psi (186 kPa)	30 min.	<ul style="list-style-type: none"> <li>Dental handpieces (wrapped or unwrapped).</li> </ul> <p>Note: Verify acceptability of sterilization parameters with handpiece manufacturer.</p>
 Programmable User Defined	250°F (121°C) to 275°F (135°C)	3 min. to 45 min.	15 psi (104 kPa) to 31 psi (214 kPa)	0 min. to 60 min.	<ul style="list-style-type: none"> <li>Items appropriate for user's defined parameters.</li> </ul> <p><b>Caution</b> These cycles have not been FDA cleared for medical use. All material processed in these cycles must be validated by the user to ensure sterility of the processed load.</p> <p>Programmable cycles 1 and 2 are provided for those applications requiring sterilization parameters different than the preset cycles. When choosing cycle parameters it is important to properly coordinate sterilization temperature with cycle time to achieve sterilization. In these cycles the vent speed can also be set to fast or slow as needed for the type of load being processed.</p>

1. The pressure shown in this table is for reference only. It's the ideal pressure of saturated steam at the sterilization temperature. The pressure shown on the sterilizer display may be higher.  
2. Dry time can be changed from 0 to 60 minutes. Refer to Cycle Operation.

## To Program Cycle Buttons...

Step	Action	Description
1	Press desired button: 	This selects the button that will be programmed.
2	Press: 	Program sterilization temperature
	Adjust: 	The "+" and "-" buttons adjust the temperature by 1° increments.
3	Press: 	Program sterilization time
	Adjust: 	The "+" and "-" buttons adjust the time by 1-minute increments.

Step	Action	Description
4	Press: 	Program vent speed
	Adjust: 	Pressing "+" changes setting: FAST Pressing "-" changes setting: SLOW
5	Press: 	Program dry time (0 to 60 minutes)
	Adjust: 	The "+" and "-" buttons adjust the time by 1-minute increments.
6	Press: 	The display will show the new cycle parameters.

**NOTE:**  
Pressing the STOP button during this procedure will abort the changes, and revert to the original settings. The programmed settings are retained under Program # button <1> or <2>. Even if power is interrupted, or the unit is unplugged the setting will be retained.

**\* Refer to the User Guide for complete Cycle Operation procedures**